

Technics

Stereo Integrated Amplifier SU-A700 SU-A600

Operating Instructions

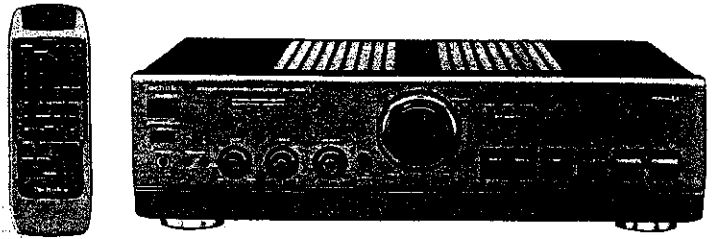

The photograph shows the SU-A700 model.

The configuration of the ventilation holes differs according to area.

Notes:

- The "EB" area code, for example, indicates United Kingdom specifications.
- The "EB" indication is shown on the packing case.

Before operating this unit, please read these instructions completely.

E EG EB EO GC GN

RQT1966-B

Dear Customer

Thank you for purchasing this product.
For optimum performance and safety, please read these instructions carefully.

These operating instructions are applicable to models SU-A700 and SU-A600.
These operating instructions, however, fundamentally explain the operation of model SU-A700.

Contents



• Accessories	2	• Remote Control Operation	
• Caution for AC mains lead		SU-A700 only	12
(For United Kingdom).....	3	• Suggestions for Safety	14
• Connections	4	• Technical Specifications	15
• Front Panel Controls and Functions	7	• Maintenance	15
• Listening to Sound	8	• Troubleshooting Guide	Back cover
• Recording	10		
• Remote Control Transmitter			
SU-A700 only	11		

For areas except United Kingdom, Europe, Australia and N.Z.

CAUTION:

The AC voltage differs according to the area.
Be sure to set the proper voltage in your area before use.
(For details, please refer to page 5.)

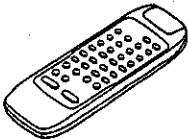
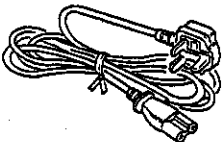
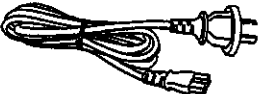
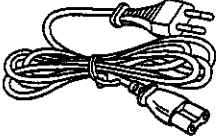
Accessories

• AC power supply cord	1	• Remote control transmitter (EUR642210)	1
(For United Kingdom)		SU-A700 only	
(For Australia and N.Z.)			
		• Batteries	2
		SU-A700 only	
			
		• Power plug adaptor	1
		(Not supplied for United Kingdom, Europe, Australia and N.Z.)	
			

Caution for AC mains lead

(For United Kingdom)

("EB" area code model only)

For your safety, please read the following text carefully.

This appliance is supplied with a moulded three pin mains plug for your safety and convenience.

A 5-ampere fuse is fitted in this plug.

Should the fuse need to be replaced please ensure that the replacement fuse has a rating of 5-ampere and that it is approved by ASTA or BSI to BS1362.

Check for the ASTA mark  or the BSI mark  on the body of the fuse.

If the plug contains a removable fuse cover you must ensure that it is refitted when the fuse is replaced.

If you lose the fuse cover the plug must not be used until a replacement cover is obtained.

A replacement fuse cover can be purchased from your local dealer.

CAUTION!

IF THE FITTED MOULDED PLUG IS UNSUITABLE FOR THE SOCKET OUTLET IN YOUR HOME THEN THE FUSE SHOULD BE REMOVED AND THE PLUG CUT OFF AND DISPOSED OF SAFELY.

THERE IS A DANGER OF SEVERE ELECTRICAL SHOCK IF THE CUT OFF PLUG IS INSERTED INTO ANY 13-AMPERE SOCKET.

If a new plug is to be fitted please observe the wiring code as shown below.

If in any doubt please consult a qualified electrician.

IMPORTANT

The wires in this mains lead are coloured in accordance with the following code:

Blue: Neutral

Brown: Live

As the colours of the wires in the mains lead of this appliance may not correspond with the coloured markings identifying the terminals in your plug, proceed as follows:

The wire which is coloured BLUE must be connected to the terminal in the plug which is marked with the letter N or coloured BLACK.

The wire which is coloured BROWN must be connected to the terminal in the plug which is marked with the letter L or coloured RED.

Under no circumstances should either of these wires be connected to the earth terminal of the three pin plug, marked with the letter E or the Earth Symbol .

Before use

Remove the connector cover as follows.

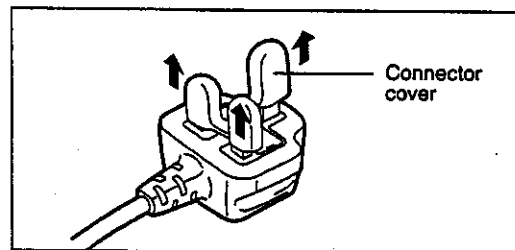

How to replace the fuse

1. Remove the fuse cover with a screwdriver.

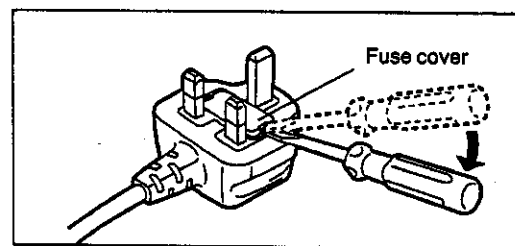

2. Replace the fuse and attach the fuse cover.

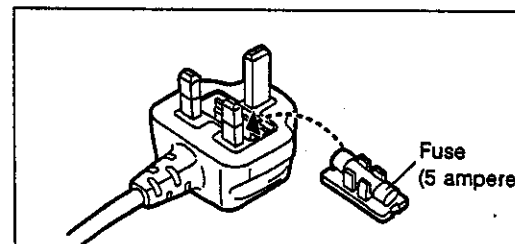

Connections

To connect to each terminal

Make connections to each component in the system by using stereo connection cables (not included).

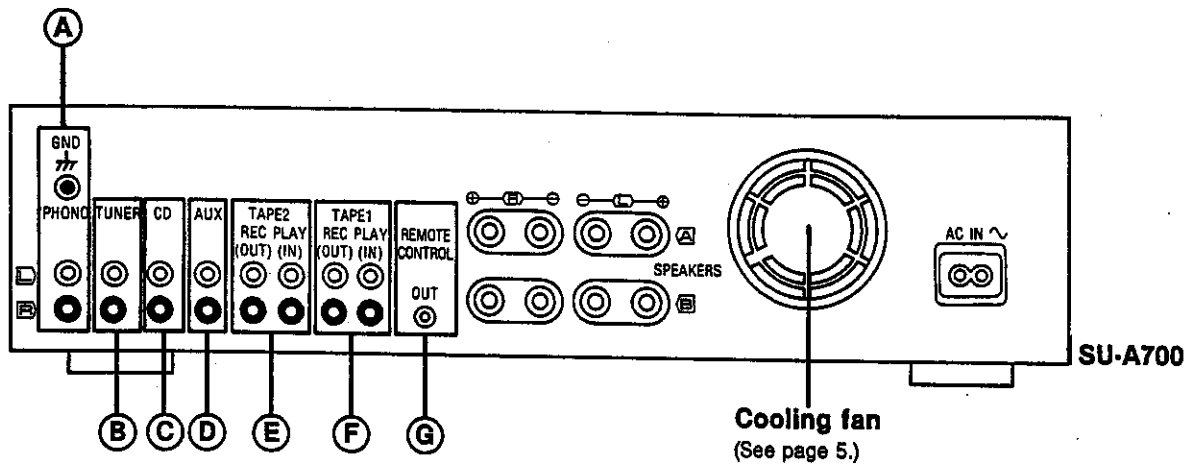

A "PHONO" terminals

Connect to a turntable.

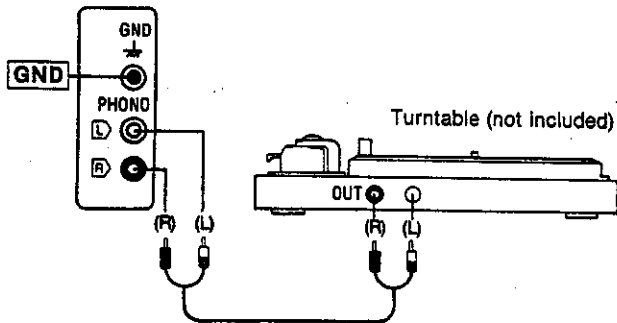

C "CD" terminals

Connect to a compact disc player.

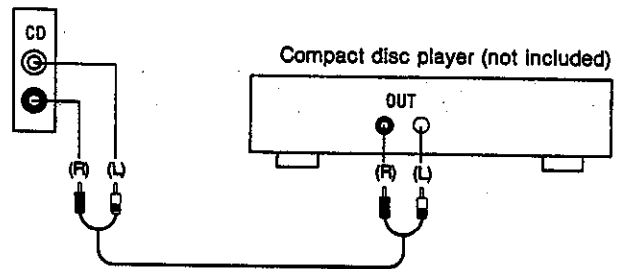

■ "GND" terminal

This terminal is for use with a turntable which has a ground wire.

B "TUNER" terminals

Connect to a tuner.

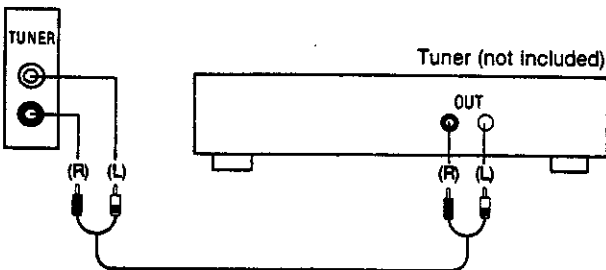

D "AUX" terminals

Connect to a component such as a video disc player (audio only connectable), etc.

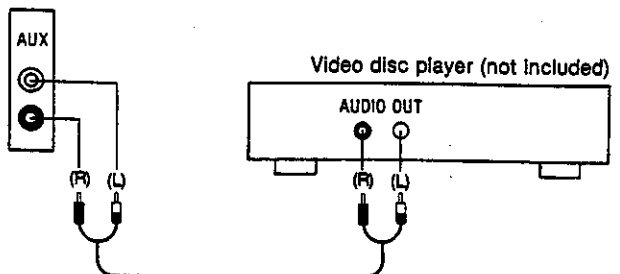

E "TAPE 2" terminals

Connect to a second tape deck (Tape deck 2) or a graphic equalizer, etc.

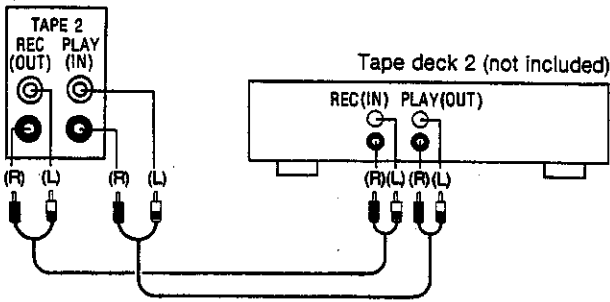

F "TAPE 1" terminals

Connect to a first tape deck (Tape deck 1) or a digital compact cassette deck (DCC), etc.

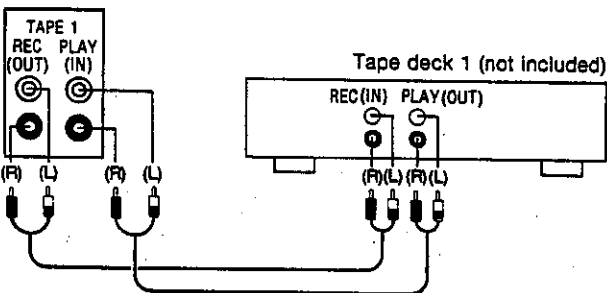

G "REMOTE CONTROL OUT" terminals

SU-A700 only

These terminals can be used only with Technics tape deck and compact disc player which have the appropriate remote control terminal. (Consult your dealer for details.)

Proper connection with remote control connection cables will allow control of some functions from this unit's remote control transmitter. (See pages 12-13 for details.)

Connect to a tape deck and/or compact disc player as shown below.

If a tape deck is not being used, the compact disc player can be connected directly (dotted line).

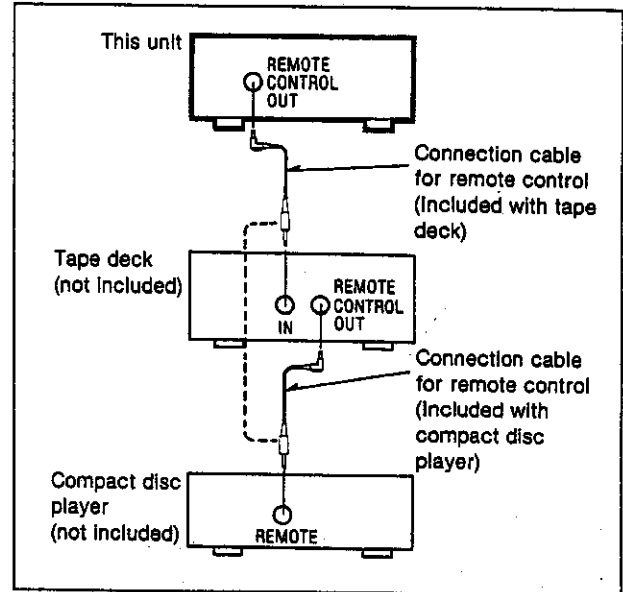

Note:

For a compact disc player with a remote control sensor, the above connection is not necessary.

To set the power voltage SU-A600 only

For areas except United Kingdom, Europe, Australia and N.Z.

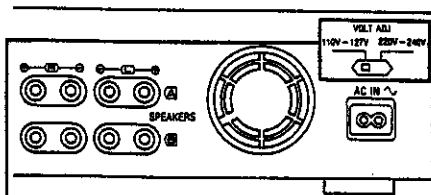

Set the voltage selector to "110 V-127 V" or "220 V-240 V" according to the area in which the unit will be used.

[Use a minus (-) screwdriver]

Note:

Note that this unit will be seriously damaged if this setting is not made correctly.

About the cooling fan

The cooling fan operates at high power output levels only. (There is no cooling fan for some countries.)

Connections (continued)

To connect to speakers

One pair of speakers can be connected to the "A" terminals of this unit and one pair to the "B" terminals, or only one pair of bi-wired speakers can be connected to all terminals.

To connect main and/or second speakers

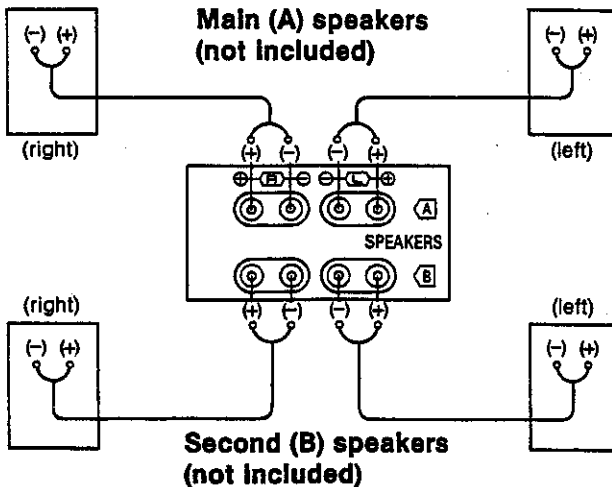

■ Load Impedance

- When only the "A" or only the "B" terminals are used: 4–16 ohms
- When both the "A" and the "B" terminals are used simultaneously: 8–16 ohms

To connect bi-wired speakers (not included)

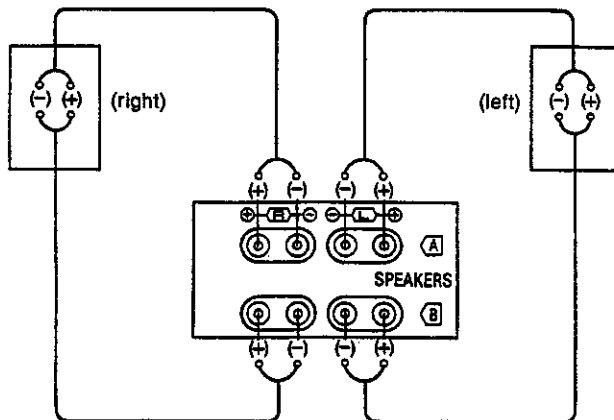

Note: Connect only bi-wired speakers in this way.

■ Load Impedance

When bi-wired speakers are used: 4–16 ohms

■ Bi-wiring

The treble range and the bass range of the speakers are connected to the speaker terminals of the amplifier by using two speaker connection cords separately for each. As a result of making connections in this way, sound can be reproduced with much greater nuance and detail, with the feelings of air oscillation and deepness of sound provided by an input source that suppresses reciprocal band-range interference. (Refer to the operating instructions of the speakers.)

To connect cords to terminals

- ① Strip off the outer covering, and twist the center conductor. 10 mm Twist
- ② Turn completely to the left. ② ③
- ③ Insert the wire and turn completely to the right. Pull the cord to assure a proper connection. ③

Note:

To prevent damage to circuitry, never short-circuit the positive (+) and negative (-) speaker wires.

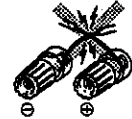

For United Kingdom only

When using banana plugs

Use with the speaker terminal knob tightened completely.

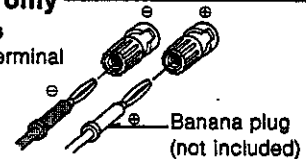

To connect the AC power supply cord (included)

FOR UNITED KINGDOM ONLY
BE SURE TO READ THE CAUTION FOR THE AC POWER SUPPLY CORD ON PAGE 3 BEFORE CONNECTING THE AC POWER SUPPLY CORD.

Connect the AC power supply cord (included) after all other cables and cords are connected.

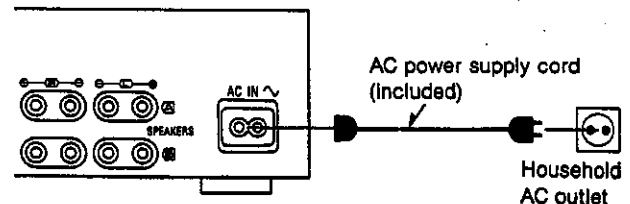

(For areas except Australia and N.Z.) Insertion of Connector

Even when the connector is perfectly inserted, depending on the type of inlet used, the front part of the connector may jut out as shown in the drawing. However there is no problem using the unit.

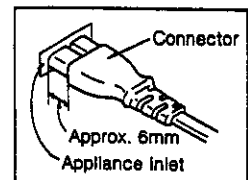

Note:

The configuration of the AC power supply cord differs according to area.

Not supplied for United Kingdom, Europe, Australia and N.Z.

If the power plug will not fit your socket, use the power plug adaptor (included).

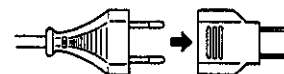

Front Panel Controls and Functions

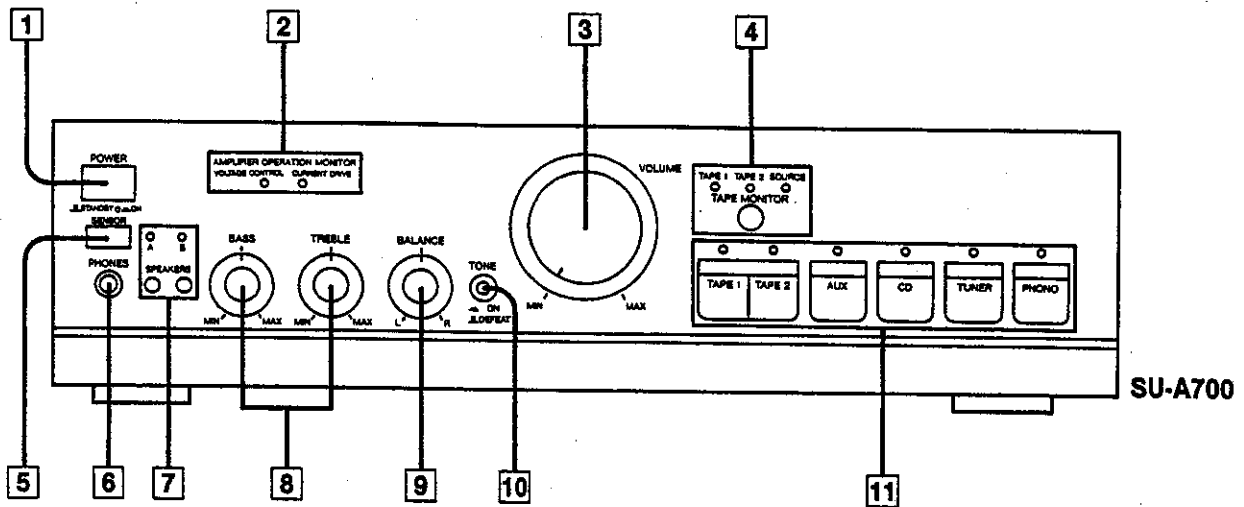

1 Power "STANDBY \downarrow /ON" switch (POWER, \blacksquare STANDBY \downarrow = ON)

Press to switch the unit from on to standby mode or vice versa. In standby mode, the unit is still consuming a small amount of power.

2 Operation Indicators (AMPLIFIER OPERATION MONITOR)

These indicators illuminate to indicate the operating condition of this unit.

VOLTAGE CONTROL:

When the power is switched ON, this indicator illuminates when the unit is in the operating condition.

CURRENT DRIVE:

When the power is switched ON, this indicator illuminates after about 4 seconds when the unit is in the operating condition.

If an abnormal condition in the circuitry is detected, such as DC voltage appearing in the output or a short-circuit of the positive (+) and negative (-) wires from the speaker terminals, the protection circuit functions and this indicator will not illuminate.

3 Volume control (VOLUME)

4 Tape-monitor button/indicators (TAPE MONITOR)

This button is used to monitor the recorded sound during recording.

TAPE 1

Set to this position to monitor the sound from the equipment connected to the "TAPE 1" terminals.

TAPE 2

Set to this position to monitor the sound from the equipment connected to the "TAPE 2" terminals.

SOURCE

Set to this position to listen to a phono disc, radio broadcast, compact disc, etc.

(See pages 8 and 10.)

5 SU-A700 only

Remote control signal receptor (SENSOR)

Receives the signals from the remote control.

6 Headphones jack (PHONES)

(See page 9.)

7 Speaker select buttons/indicators (SPEAKERS)

These select buttons are used to select the speakers to be used. (See page 8.)

8 Tone controls (BASS/TREBLE)

The bass control is used to adjust the low-frequency sound range, and the treble control is used to adjust the high-frequency sound range.

9 Balance control (BALANCE)

This control is used to adjust the left/right volume balance.

10 Tone control button (TONE)

This switch is used to set the tone control circuit (bass, treble) to ON or DEFEAT.

11 Input selectors/indicators

These selectors are used to select the sound source to be heard, such as a disc, radio broadcast, etc. (See page 8.)

Listening to Sound

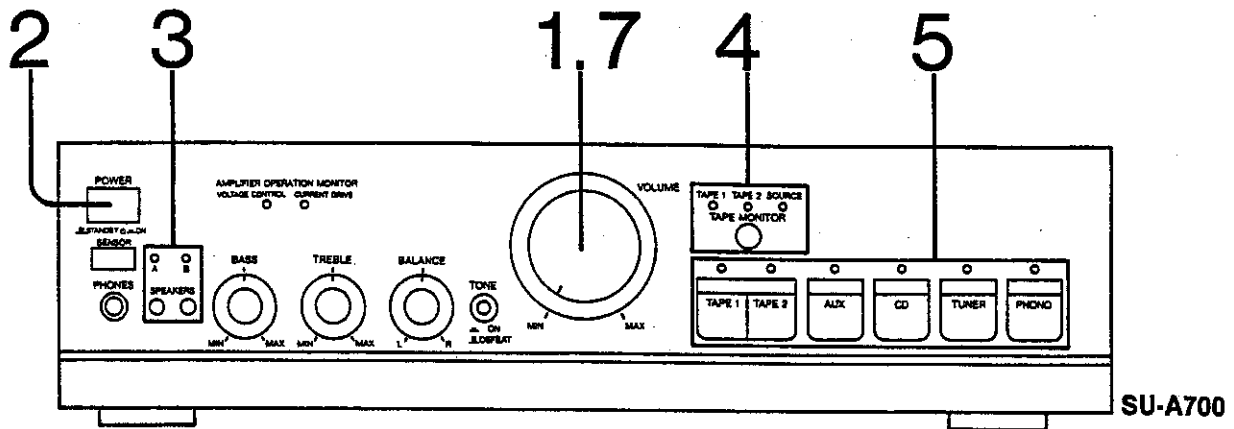

1 Set the volume control to the "MIN" position.

2 Switch ON the power.

3 Select the speaker system to be used. The corresponding indicator above will illuminate to indicate which speaker system is selected.

A: Sound can be heard from the speakers connected to the "A" terminals.

B: Sound can be heard from the speakers connected to the "B" terminals.

A and B: Sound can be heard simultaneously from the speakers connected to the "A" terminals and the "B" terminals. Or, if bi-wired speakers are connected, sound can be heard from them.

off: No sound will be heard from the speakers. (Both indicators will turn off.)

4 Press the tape monitor button so that the "SOURCE" indicator illuminates.

Notes:

When a graphic equalizer connected to the "TAPE 1" or "TAPE 2" terminals is used, set the selector to the "TAPE 1" or "TAPE 2" position.

5 Select the sound source. **TAPE 1:** Press this button to listen to equipment connected to the "TAPE 1" terminals.

TAPE 2: Press this button to listen to equipment connected to the "TAPE 2" terminals.

AUX: Press this button to listen to equipment connected to the "AUX" terminals.

CD: Press this button to listen to compact discs.

TUNER: Press this button to listen to radio broadcasts.

PHONO: Press this button to listen to phono discs.

6 Begin operation of the components to be used.

Refer to the operating instructions of each component.

7 Adjust the volume level.

Turn the volume control to the desired level.

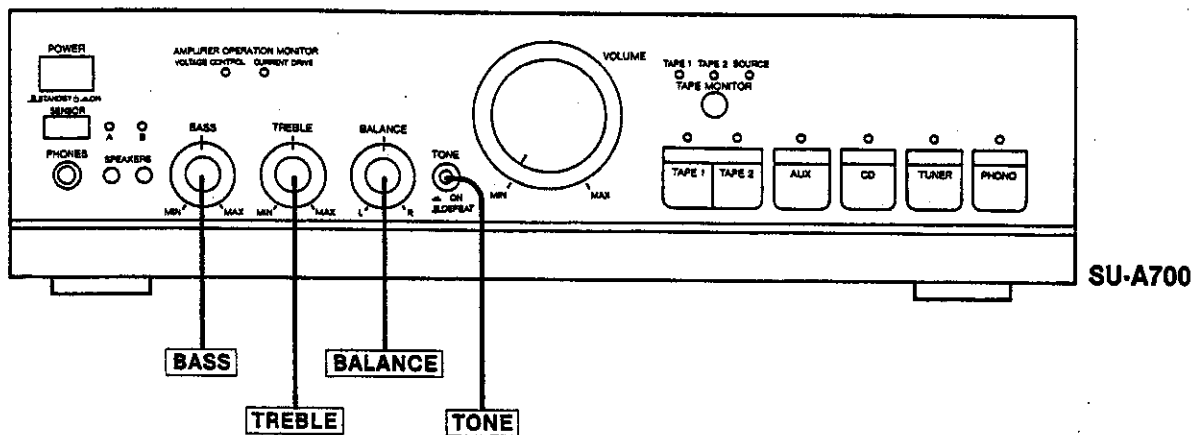

While listening to music

BALANCE

Adjust the balance for the left/right volume.

To adjust the tone quality

tone

Press the tone control switch inward to the "ON" position if you want to adjust the bass or treble tone quality.

If set to the "DEFEAT" position, tone controls have no effect, and frequency response becomes flat.

BASS

Adjust the low-frequency sound to the desired tone quality.

TREBLE

Adjust the high-frequency sound to the desired tone quality.

While listening through headphones

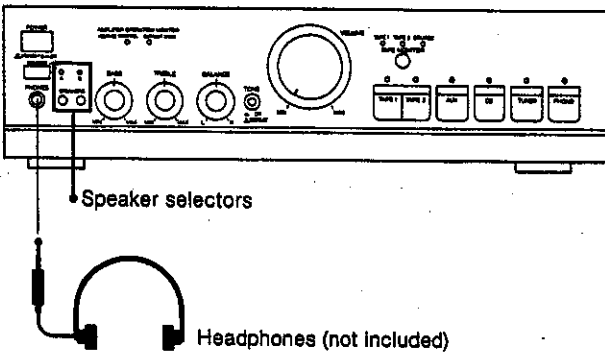

- Reduce the volume level before connecting headphones.
- If the sound from the speakers is not wanted, set the speaker selectors to the "off" position.
- Avoid listening for prolonged periods of time to prevent hearing damage.

After listening is finished

Use the volume control to reduce the volume level and switch OFF the power of each unit.

Recording

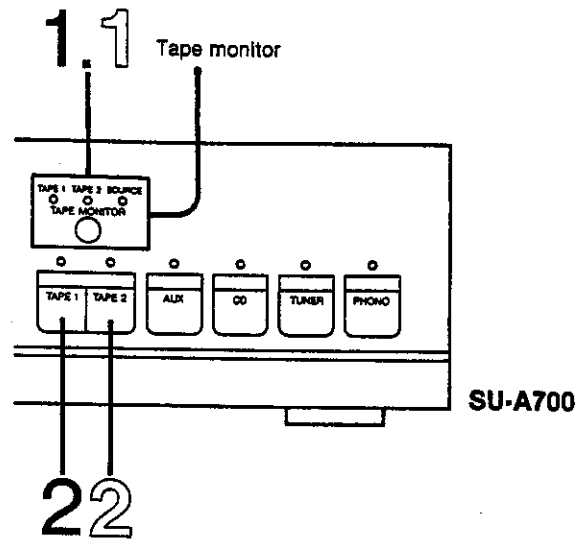
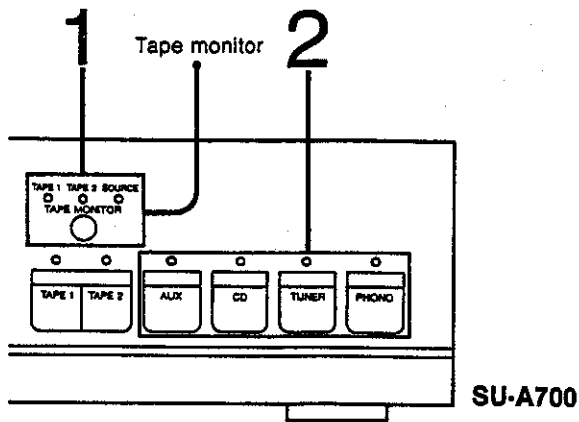

To record from compact discs, etc.

- 1** Set the tape-monitor button to the "SOURCE" position.
- 2** Select the program source to be recorded.
AUX: Press this button to record from equipment connected to the "AUX" terminals.
CD: Press this button to record from compact discs.
TUNER: Press this button to record from radio broadcasts.
PHONO: Press this button to record from phono discs.
- 3** Prepare the tape deck for recording.
 (Refer to the operating instructions for the tape deck for detailed adjustment of the recording level, etc.)
- 4** Start recording, and play back the source.

Tape-to-tape recording

Tape-to-tape recordings can be made if two regular tape decks, or one regular tape deck and a digital compact cassette deck (DCC), are connected to the rear panel of this unit.

Note:

Tape deck 1 (first tape deck) is the tape deck connected to the "TAPE 1" terminals.

Tape deck 2 (second tape deck) is the tape deck connected to the "TAPE 2" terminals.

To record from tape deck 2 to 1

- 1** Set the tape-monitor button to the "SOURCE" position.
- 2** Press the "TAPE 2" button.
- 3** Start tape deck 1 for recording and tape deck 2 for playback.

To record from tape deck 1 to 2

- 1** Set the tape-monitor button to the "SOURCE" position.
- 2** Press the "TAPE 1" button.
- 3** Start tape deck 2 for recording and tape deck 1 for playback.

■ To check the sound recorded

With a tape deck with 3 heads, it is possible to check the sound recorded on the tape.

Set the tape monitor to "TAPE 1" or "TAPE 2" and the monitor switch on the tape deck to "TAPE."

TAPE 1: when recording on tape deck 1 (first tape deck)

TAPE 2: when recording on tape deck 2 (second tape deck)

Remote Control Transmitter

SU-A700 only

Insertion of remote control transmitter batteries

1. Open the cover.
2. Insert the batteries.
 - Be sure to insert according to the (+) and (-) indications in the battery compartment.
 - Use two UM-4, "AAA" R03 (1.5 V) size batteries.

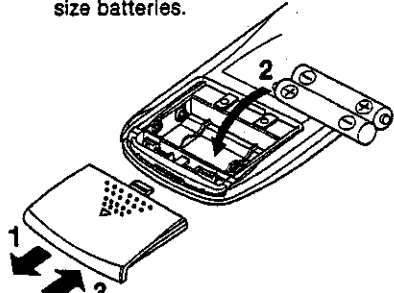

3. Close the cover.

■ Battery life

Battery life is about one year. (Battery life may vary depending upon the frequency of use and other conditions of use.)

The batteries should be replaced if the unit cannot be operated even when the remote control transmitter is brought close to the unit.

■ Battery notes

- Be sure that batteries are inserted so that they are placed correctly with respect to the (+) and (-) indications in the battery compartment. If the batteries are not inserted correctly, they may leak and damage the remote control transmitter.
- Do not use rechargeable (nickel-cadmium) type batteries.

- Do not mix old and new batteries, or batteries of different types (such as carbon and alkaline.)
- If the remote control transmitter is not to be used for a long period of time, take out the batteries and store them in a cool, dark place.
- Remove and dispose of worn-out batteries.
- Never attempt to recharge or short-circuit the batteries, and do not disassemble them or expose them to excessive heat or throw them into a fire.
- If a battery leaks, remove both batteries and dispose of them, and then thoroughly clean the battery compartment before inserting new batteries.

Remote control transmitter operation notes

Face about 7 meters in front of the sensor.

(This actual range will depend on the angle at which the remote control is used.)

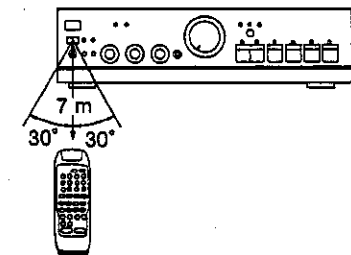

Face it toward the remote control signal receptor of this unit.

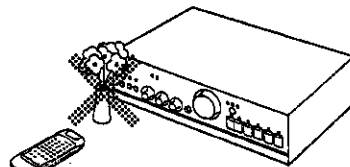

(Obstacles should be avoided.)

Be sure the transmitter part of the remote control transmitter and the receptor part of this unit are free from dust.

Excessive dust might prevent reception.

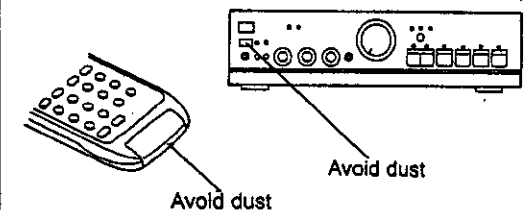

Other notes

1. Do not expose the receptor (on this unit) to direct sunlight or other strong light, because to do so might result in incorrect operation.
2. Do not use a remote control transmitter for a TV set, a VCR or other video component at the same time as this remote control transmitter is being used, because to do so might result in incorrect operation.
3. If this unit is installed in a rack with glass doors, the glass door's thickness or color might make it necessary to use the remote control transmitter a shorter distance from the unit.

Remote Control Operation

SU-A700 only

- This remote control transmitter can be used to operate CD players and tape decks which are equipped with remote control terminals or remote control sensors, or to operate tuners which are equipped with remote control sensors. Consult your dealer for details.
- For detailed information concerning operation steps, etc., please refer to the appropriate page for each unit and the respective operating instructions.
- Make sure that the power of each unit is set to the "ON" position before beginning the operations.

NOTE:

Face this remote control transmitter toward the main unit to operate the main unit or other units which are connected to the main unit by means of a remote control cable (See page 5).
To operate any other unit, face this remote control transmitter toward that unit.

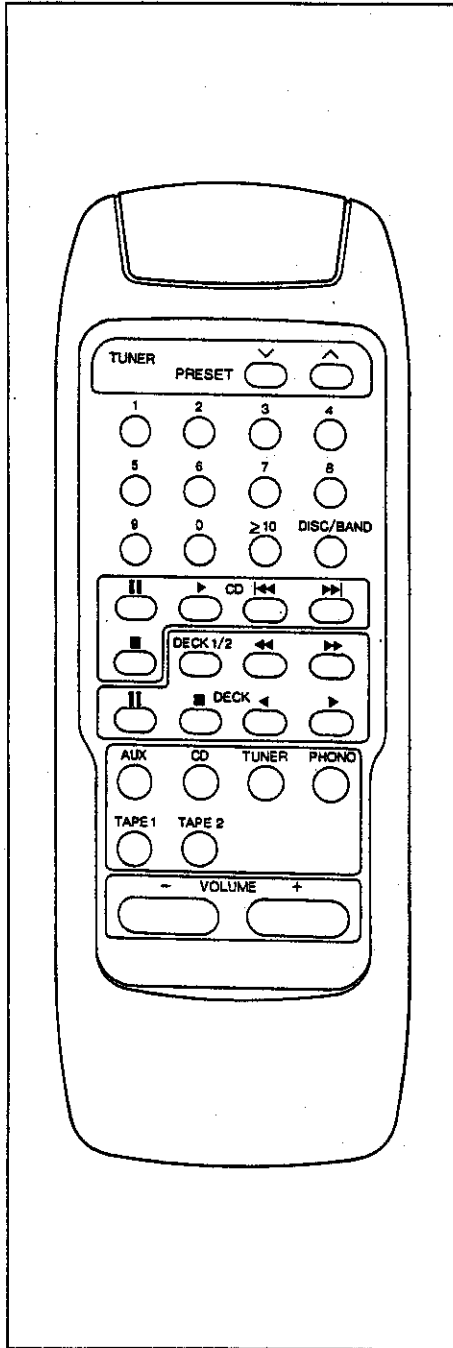

To operate the amplifier

To select an input source

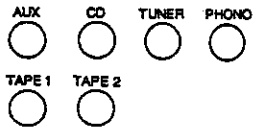

To adjust the volume level

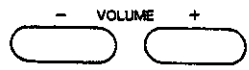

To listen to radio broadcasts

To select the desired channel sequentially



Select the desired preset channel.

To select the desired channel directly

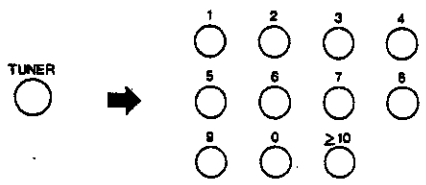

Specify the preset channel using the numeric button(s).

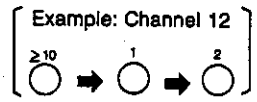

To select the desired band



The band changes each time the button is pressed.

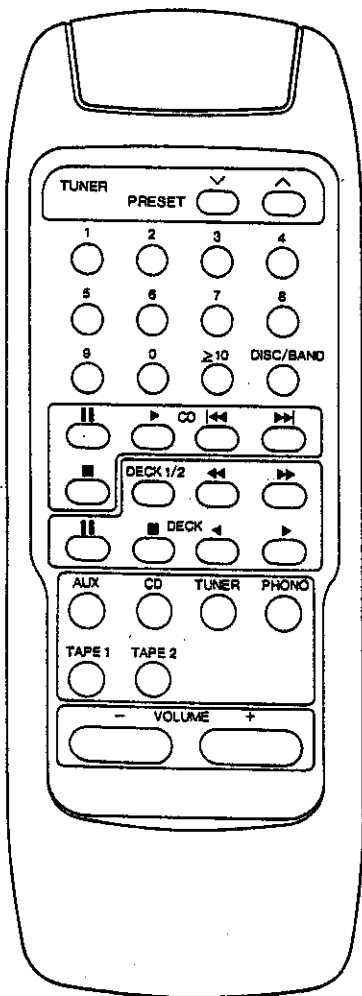

To listen to compact discs														
To start play 														
To start play from the desired track														
	<table border="0"> <tr> <td></td> <td></td> <td></td> <td></td> <td rowspan="3"> Select the desired track number. [Example: track 12] [→ →] </td> </tr> <tr> <td></td> <td></td> <td></td> <td></td> </tr> <tr> <td></td> <td></td> <td></td> <td></td> </tr> </table> <p>→ For CD changer Select the desired disc by pressing "DISC/BAND" and then appropriate numeric button ("1" – "5").</p>					Select the desired track number. [Example: track 12] [→ →]								
				Select the desired track number. [Example: track 12] [→ →]										
To stop play														
To stop play temporarily	Press to resume play.													
To skip a track														
To listen to tapes														
<p>DECK 1/2 Only when using a double cassette deck Select the tape deck (DECK 1 or DECK 2). → (Reverse) (Forward)</p> <p>The remote control indicator of the cassette deck is changed over each time the button is pressed.</p>														
To stop play														
To stop play temporarily	Press to resume play.													
To fast-forward or rewind the tape														

Suggestions for Safety

■ Use a standard AC wall outlet

1. **Use of an AC power source of high voltage, such as for an air conditioner, is very dangerous.**

There is the possibility that a fire might be caused by making such a connection.

2. **A DC power source cannot be used.**

Be sure to check the power source carefully, especially on a ship or other place where DC is used.

■ Grasp the plug when disconnecting the power supply cord

1. **Wet hands are dangerous.**

A dangerous electric shock may result if the plug is touched by wet hands.

2. **Never place heavy items on top of the power supply cord, and never force it to bend sharply.**

■ Place the unit where it will be well ventilated

Place this unit at least 10 cm (4") away from wall surfaces, etc. Be careful that curtains and similar materials do not obstruct the ventilation holes.

■ Avoid places such as the following:

In direct sunlight or in other places where the temperature is high.

In places where there is excessive vibration or humidity.

Such conditions might damage the cabinet and/or other component parts and thereby shorten the unit's service life.

■ Be sure to place the unit on a flat, level surface.

If the surface is inclined, a malfunction may result.

■ Never attempt to repair or reconstruct this unit

A serious electric shock might occur if this unit is repaired, disassembled or reconstructed by unauthorized persons, or if the internal parts are accidentally touched.

■ Take particular care if children are present

Never permit children to put anything, especially metal, inside this unit. A serious electric shock or malfunction could occur if articles such as coins, needles, screwdrivers, etc. are inserted through the ventilation holes, etc. of this unit.

■ If water is spilled on the unit

Be extremely careful if water is spilled on the unit, because a fire or serious electric shock might occur. Immediately disconnect the power cord plug, and consult with your dealer.

■ Avoid spray-type insecticides

Insecticides might cause cracks or "cloudiness" in the cabinet and plastic parts of this unit. The gas used in such sprays might, moreover, be ignited suddenly.

■ Never use alcohol or paint thinner

These and similar chemicals should never be used, because they might cause flaking or cloudiness of the cabinet finish.

■ Disconnect the power supply cord if the unit will not be used for a long time

If the unit is left for a long time with the power ON, this will not only shorten its useful operation life, but may also cause other troubles.

■ If trouble occurs

If, during operation, the sound is interrupted or indicators no longer illuminate, or if abnormal odor or smoke is detected, immediately disconnect the power cord plug, and contact your dealer or an Authorized Service Center.

Technical Specifications (DIN 45 500)

20 Hz–20 kHz continuous power output	
both channels driven	[SU-A700] : 2 × 45 W (8 Ω) [SU-A600] : 2 × 40 W (8 Ω)
1 kHz continuous power output	
both channels driven (THD: 1%)	[SU-A700] : 2 × 55 W (8 Ω) 2 × 80 W (4 Ω) [SU-A600] : 2 × 50 W (8 Ω) 2 × 70 W (4 Ω)
63 Hz–12.5 kHz continuous power output	
both channels driven (THD: 0.7%)	[SU-A700] : 2 × 50 W (8 Ω) 2 × 70 W (4 Ω) [SU-A600] : 2 × 45 W (8 Ω) 2 × 65 W (4 Ω)
Total harmonic distortion	
rated power at 20 Hz–20 kHz	0.01 % (8 Ω)
Intermodulation distortion (50 Hz: 7 kHz = 4:1, SMPTE)	
rated power	0.007 % (8 Ω)
Residual hum and noise	1 mV
Damping factor	60 (8 Ω) 30 (4 Ω)
Headphones output level/impedance	
Load impedance	540 mV/47 Ω
A or B, BI-WIRING	
A and B	4 Ω–16 Ω 8 Ω–16 Ω
Input sensitivity/impedance	
PHONO MM	2.5 mV/47 kΩ
TUNER, CD, AUX, TAPE 1, TAPE 2	150 mV/22 kΩ
Phono maximum input voltage (1 kHz, RMS)	
MM	150 mV (150 mV, IHF '66)
S/N (rated power, 4 Ω)	
PHONO MM	76 dB (78 dB, IHF '66)
TUNER, CD, AUX, TAPE 1, TAPE 2	91 dB (99 dB, IHF '66)
S/N at –26 dB power (4 Ω)	
PHONO MM	68 dB
TUNER, CD, AUX, TAPE 1, TAPE 2	70 dB
S/N at 50 mW power (4 Ω)	
PHONO MM	64 dB
TUNER, CD, AUX, TAPE 1, TAPE 2	64 dB

Frequency response	
PHONO MM	RIAA standard curve ±1 dB (30 Hz–15 kHz)
TUNER, CD, AUX, TAPE 1, TAPE 2	
	3 Hz–80 kHz (+0, –3 dB) +0 dB, –0.3 dB (20 Hz–20 kHz)
Tone controls	
BASS	50 Hz, +10 to –10 dB
TREBLE	20 kHz, +10 to –10 dB
Output voltage	
TAPE 1, TAPE 2 REC OUT	150 mV
Channel balance (AUX 250 Hz–6.3 kHz)	±1 dB
Channel separation (AUX 1 kHz)	50 dB

■ GENERAL

Power consumption	200 W
Power supply	
For Europe	50 Hz/60 Hz AC, 230 V
For United Kingdom, Australia and N.Z.	50 Hz/60 Hz AC, 230 V–240 V
For others	50 Hz/60 Hz AC, 110 V–127 V/220 V–240 V
Dimensions (W × H × D)	430 × 125 × 318 mm
Weight	[SU-A700] : 6.4 kg [SU-A600] : 6.2 kg

Notes:

- Specifications are subject to change without notice. Weight and dimensions are approximate.
- Total harmonic distortion is measured by the digital spectrum analyzer.

For United Kingdom only

This apparatus was produced to BS 800.

Maintenance

To clean this unit, use a soft, dry cloth.
For very dirty surfaces, dip a soft cloth in a weak soap-and-water solution and wring well. After cleaning, wipe with a soft, dry cloth.

Never use alcohol, paint thinner, benzine, or a chemically treated cloth to clean this unit.

Such chemicals may damage the unit's finish.

Troubleshooting Guide

Before requesting service for this unit, check the chart below for a possible cause of the problem you are experiencing. Some simple checks or a minor adjustment on your part may eliminate the problem and restore proper operation.

If you are in doubt about some of the check points, or if the remedies indicated in the chart do not solve the problem, refer to the directory of Authorized Service Centers (enclosed with this unit) to locate a convenient service center, or consult your Technics dealer for instructions.

Problem	Probable cause(s)	Suggested remedy
Problems noted at all times		
No sound is heard when the power is switched ON.	The power cord plug is not completely inserted.	• Confirm that the power cord plug is connected completely.
	Connections to the speakers, etc. are incomplete or incorrect.	• Check to be sure that all connection wires are correctly connected.
	The input selector setting is incorrect.	• Check to be sure that the selection of the desired sound source is made correctly.
	The speaker selector is set incorrectly.	• Set it to the correct position.
When listening to stereo sound, the sound lacks depth (i.e. thin bass, tinny sound).	One of the speakers is connected out of phase [(+)→(-), (-)→(+)].	• Reconnect the speakers maintaining proper polarity [i.e., (+)→(+), (-)→(-)].
When listening to stereo sound, the left and right sounds are reversed.	The left and right speaker connections, source connections, or graphic equalizer connections are reversed.	• Check all connections and correct them if necessary.
A low-pitched noise ("hum" or "buzz") is heard.	The power cord or a fluorescent light, etc., is near the connection wires.	• Try separating this unit as far as possible from the electric appliance.
Sound is not heard from one of the speakers.	The speaker wires are disconnected.	• Check and correct the connections of the speaker wires.
	The balance control is set too far to one side.	• Set so that sounds are heard at the center, between the speakers.
Sound stops during a performance, or no sound is heard when the power is switched ON.	The protection circuitry has functioned because the positive and negative speaker connection wires are "shorted", speakers with an impedance less than the indicated rated impedance of the amplifier are used, or DC voltage appears in the output, causing the protection circuitry to function.	• Switch OFF the power, and, after determining and correcting the cause, switch ON the power once again. • Use the speakers of the proper impedance rating.

SU-A700 only

While using the remote control transmitter		
The remote control transmitter does not function.	Batteries are incorrectly placed.	• Insert the batteries so that the positive (+) and negative (-) polarities are correct.
	The remote control transmitter batteries are dead.	• Replace them with new batteries.
	There is an obstruction between the remote control transmitter and this unit.	• Remove the obstruction.
	The remote control transmitter is not correctly facing this unit.	• Face the remote control transmitter correctly toward this unit.

Matsushita Electric Industrial Co., Ltd.
Central P.O. Box 288, Osaka 530-91, Japan